

---

---

*Western Electric*

# LINE EQUALIZERS

23A Equalizer and 279A Equalizer Panel

For Radio Telephone Broadcasting Systems

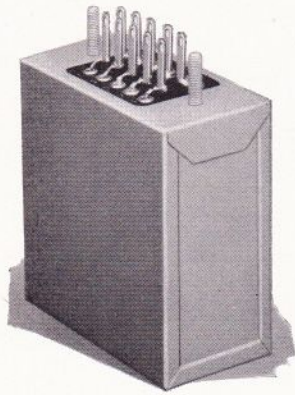

23A EQUALIZER

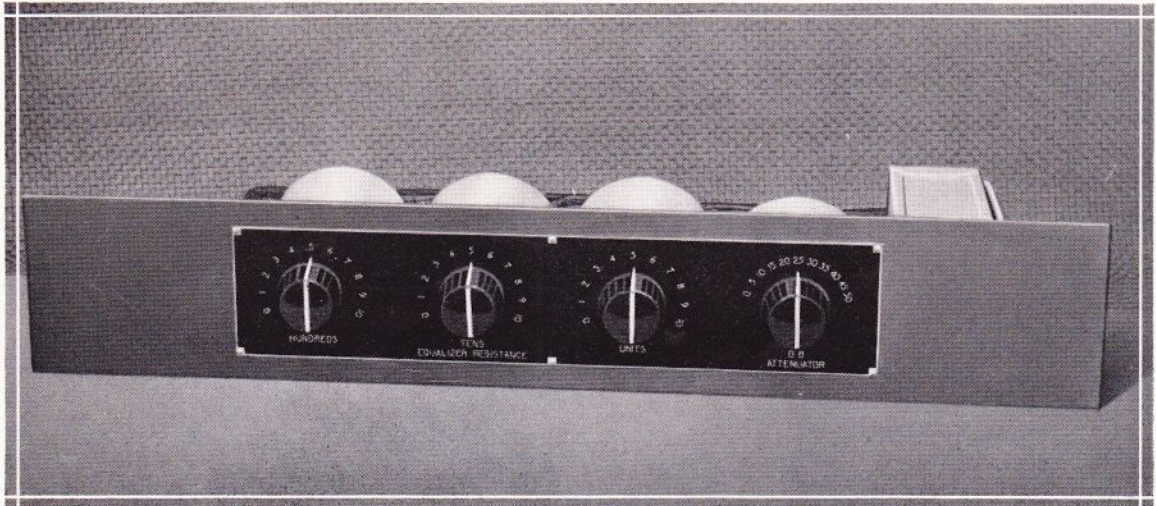

279A EQUALIZER PANEL

---

---

---



---

# *Western Electric*

## LINE EQUALIZERS

THE Western Electric 23A Equalizer and the 279A Equalizer Panel have been designed for use in radio broadcasting to correct the non-uniformity of transmission in the range from 35 to 8,000 cycles per second of non-loaded telephone cable circuits employed for the transmission of high quality program material.

23A Equalizers are intended for use on program lines which are employed frequently enough to justify the permanent association of an equalizer. The 279A Equalizer Panel, an adaptation of the 23A Equalizer Circuit, permits rapid adjustment of equalization to meet the requirements of less frequently used program lines where an equalizer is not required continuously for each line. The panel may be switched from line to line and equalization is quickly effected by predetermined settings of the control knobs on the front of the panel. The 23A Equalizer and 279A Equalizer Panel will be used to supplement each other in many cases.

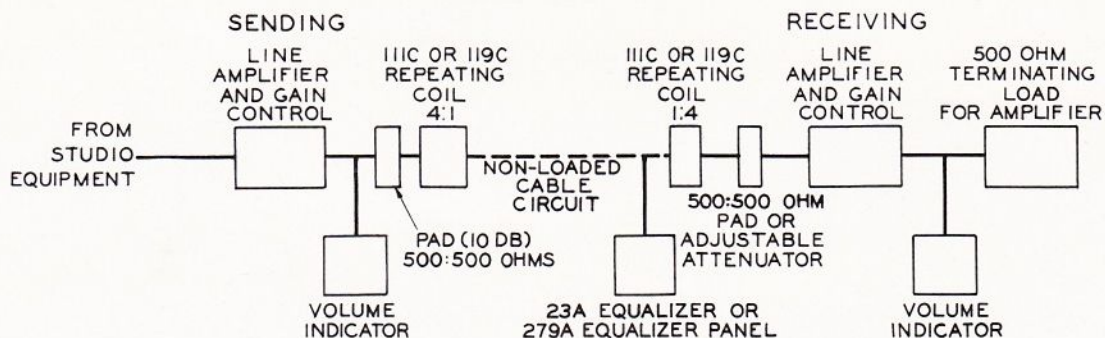

TYPICAL APPLICATION OF EQUALIZER TO 500 OHM, NON-LOADED CABLE CIRCUIT

### 23A EQUALIZER

The 23A Equalizer is of the shunt type consisting of an inductance and a capacity in parallel and a tapped series resistance, the value of which is determined at the time of installation from the transmission characteristic of the circuit. Seven resistance units are provided, the ends of which are brought out to numbered terminals to facilitate connections.

---



---

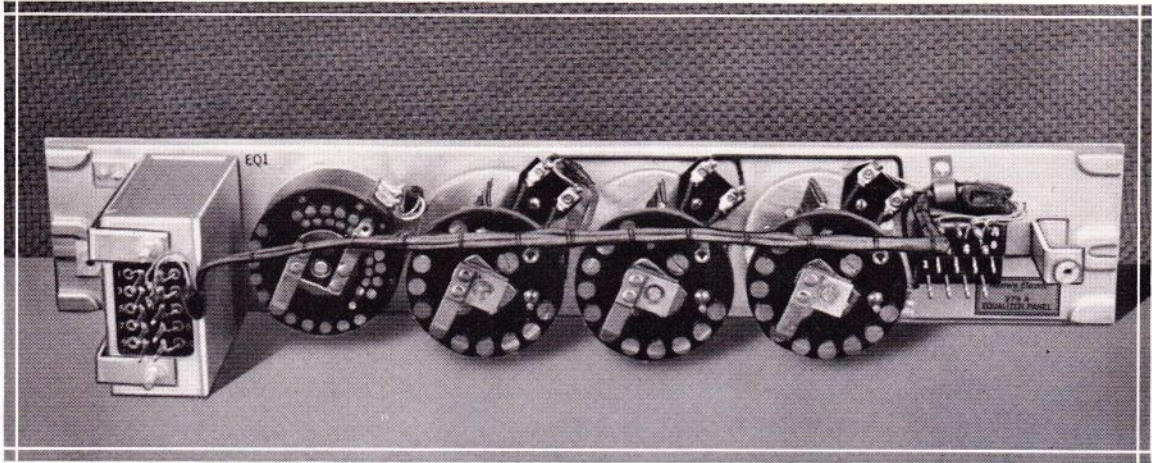

REAR VIEW OF THE 279A EQUALIZER PANEL, COVERS REMOVED.  
23A EQUALIZER MOUNTED AT THE LEFT OF PANEL

The resistance units are not connected. In making tests to determine the value of resistances to be employed, an external variable resistance box is used (connected between terminals 1 and 4 of the strip). When the correct value of resistance has been determined, the resistance box is removed from the circuit and the proper combination of fixed resistances connected. A total resistance of 322.5 ohms is available across terminals 3-4, which, experience has shown, is sufficient to meet practically all line conditions. The schematic shows the manner in which the resistance units are connected.

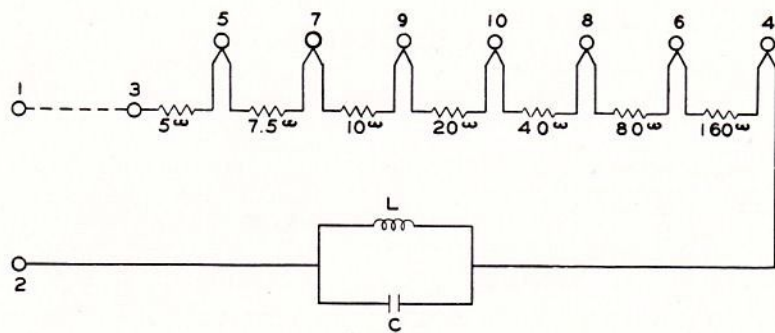

Non-loaded cable circuits, consisting entirely of one gauge, can be equalized up to the approximate lengths given below by the use of the 23A Equalizer.

For equalization with maximum deviation of 1 db.

Gauge	Length (Miles)
16	21.5
19	10
22	6.5

For equalization with maximum deviation of 2 db.

Gauge	Length (Miles)
16	25
19	11.5
22	7

The component parts are assembled in a metal case, of the dimensions shown in the

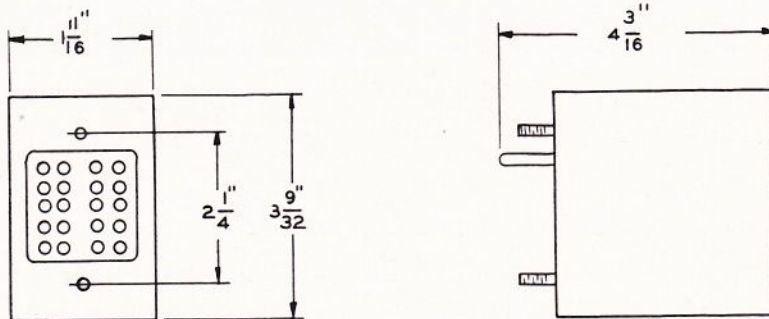

sketch, designed to mount on an equipment panel such as the Western Electric 993B Mounting Plate which mounts eight 23A Equalizers on  $1\frac{3}{4}$ " centers.

### SPECIFICATIONS

*Dimensions:* 1  $\frac{11}{16}$ " wide by 3  $\frac{9}{32}$ " high by 4  $\frac{3}{16}$ " deep.

*Finish:* Aluminum gray.

*Weight:* Approximately 3 lbs.

*Mounting:* Mounts on equipment panel such as Western Electric 993B Mounting Plate through  $\frac{7}{32}$ " holes on  $1\frac{3}{4}$ " center. Mounting bolts ( $.164$ "—32 thread) attached to metal case. Nuts and lockwashers furnished. Western Electric 993B Mounting Plate mounts eight 23A Equalizers.

*Frequency Range:* 35 to 8,000 cps.

---

---

## 279A EQUALIZER PANEL

The 279A Equalizer Panel provides an adjustable equalizer for use on lines which are not in constant service and consequently do not warrant the permanent association of a fixed equalizer with them. This adjustable equalizer may be patched to any of the program lines and the equalization and program level quickly adjusted to meet the characteristics of the line.

The 279A Equalizer Panel covers the same equalization range as the 23A. It has three adjustable series resistances connected in place of the resistance elements of the 23A to facilitate rapid readjustment of resistance in equalizing the line. Three equalization knobs are provided on the front of the 279A Panel; namely, for units, tens and hundreds of ohms of equalization resistance.

A variable attenuator of the constant impedance type, which provides a maximum attenuation of 50 db in 5 db steps, is also incorporated in this panel, and controlled by a fourth knob. This attenuator is wired to separate terminals so that by connecting these terminals through patching jacks the attenuator may be used either with the circuit to which the equalizer portion of the panel is connected, or it may be patched to any other circuit which matches its 600 ohm impedance.

The component parts of this panel are assembled on a metal panel designed for mounting on a standard relay rack or in an equipment cabinet. A mat, provided for the front of the panel, is held in place by screws which are drawn up from the rear.

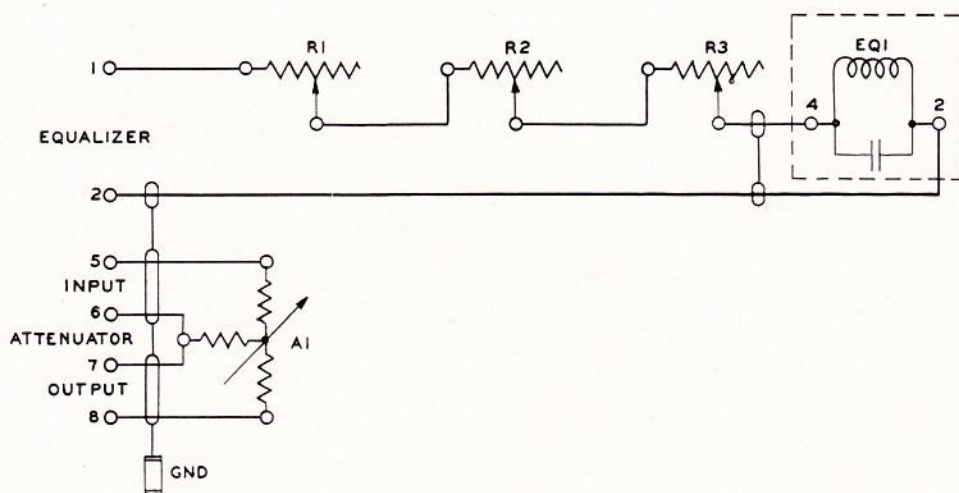

## SPECIFICATIONS

*Dimensions:* 3 1/2" by 19" wide.

*Finish:* 279A15, Aluminum panel with dark gray mat, or 279A3, Aluminum panel with black mat as specified.

*Weight:* 8 1/2 lbs.

*Mounting:* Standard 19" relay rack or equipment panel.

*Frequency Range:* 35 to 8,000 cycles.

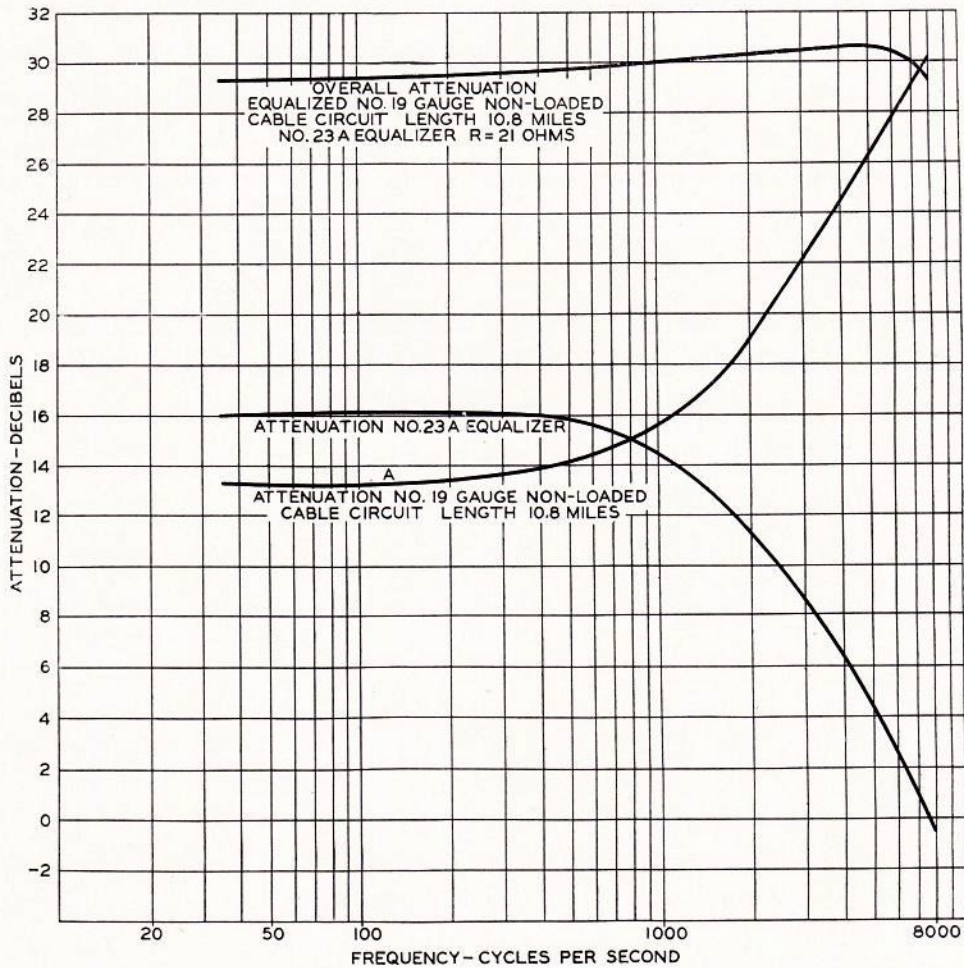

TYPICAL ATTENUATION CURVES OF 23A EQUALIZER  
AND 279A EQUALIZER PANEL

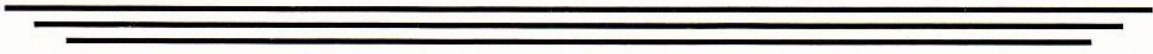

*A development of Bell Telephone Laboratories, the  
research laboratories of the American Telephone and  
Telegraph Company and the Western Electric Company*

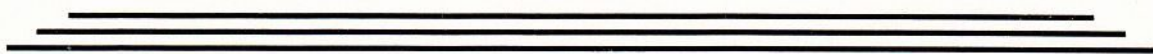

---

---

DISTRIBUTOR IN THE UNITED STATES

**GraybaR**  
ELECTRIC COMPANY

Executive Offices: 420 Lexington Avenue, New York 17, N. Y.

Offices in more than 80 principal cities

A NATIONAL ELECTRIC SERVICE

DISTRIBUTOR FOR CANADA AND NEWFOUNDLAND

*Northern Electric Company*  
LIMITED

General Offices: 1620 Notre Dame Street, W. Plant: 1261 Shearer Street,  
Montreal, P. Q., Canada

TWENTY-THREE BRANCHES FROM COAST TO COAST

